



HPA Series

850-950MHz 10W RF Power Amplifier

Features

- Frequency Range: 850-950MHz
- Gain: 40dB
- P_{out}: +40dBm
- P_{sat}: +42dBm
- IP3: +50dBm
- DC Power: 12V
- SMA Connector

Picture

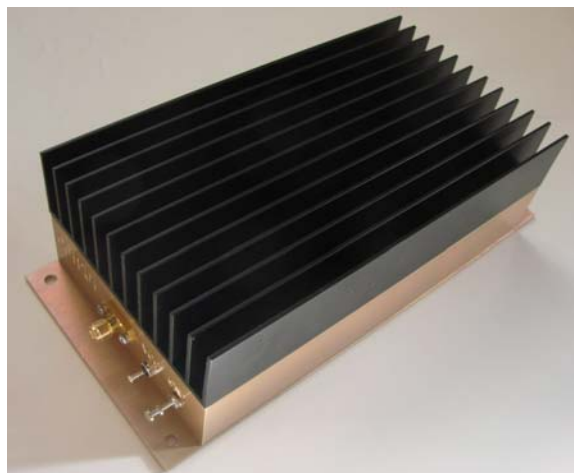

Performance measured @ 900MHz

Description

HPA-900 is a 10Watt (+40dBm) output RF Power Amplifier operating from single 12V DC power supply with frequency from 850MHz to 950MHz.

Electrical Specifications @ +25 °C, Z_S = Z_L = 50 Ω, V_{cc} = +12V

Parameter	Unit	Minimum	Typical	Maximum
Frequency Range	MHz	850		950
Small Signal Gain	dB	40	41	
Output Power P _{out} @ P _{in} = 0dBm	dBm		+40	
Saturated Power P _{sat} @ P _{in} = +5dBm	dBm		+42	
IP3	dBm		+50	
Reverse Isolation	dB		-75	
Efficiency at Pout = +40dBm	%		38	
VSWR Input			1.4:1	
DC Power Supply	V		+12	
Supply Current	mA		2650	
Size (Excluding SMA Connector)	inch	7.000" x 3.250" x 2.000"		
Weight	Oz.	24 (680g)		



HPA Series

850-950MHz 10W RF Power Amplifier

Typical Performance @ +25 °C

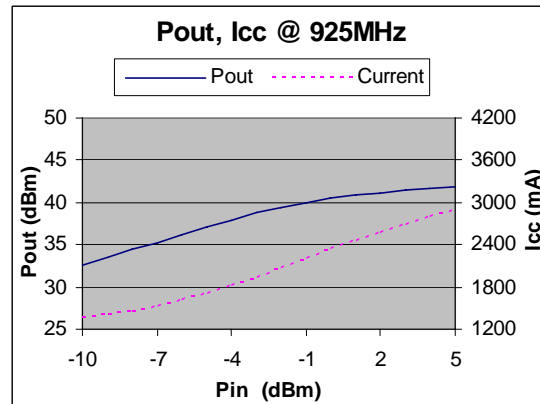
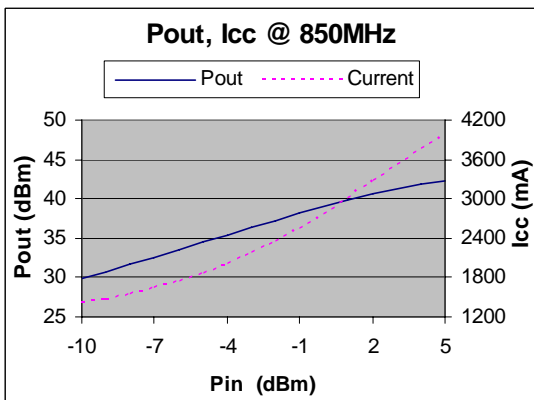
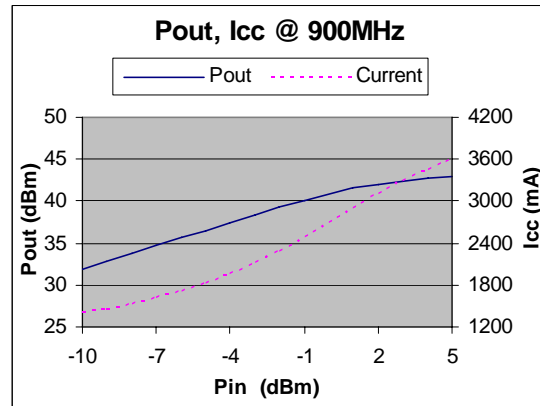
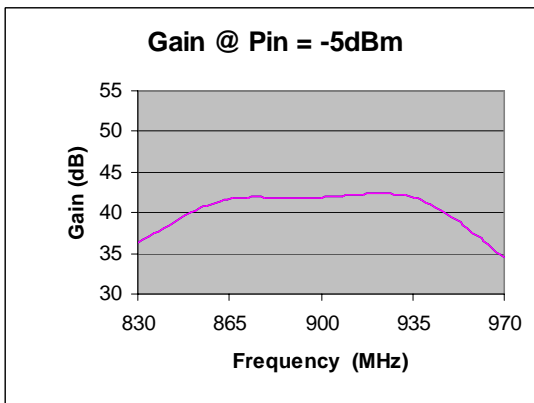
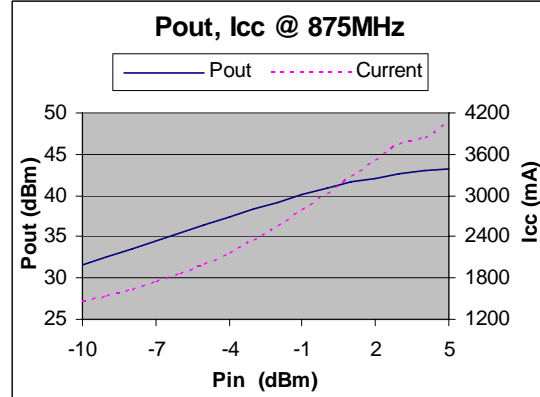
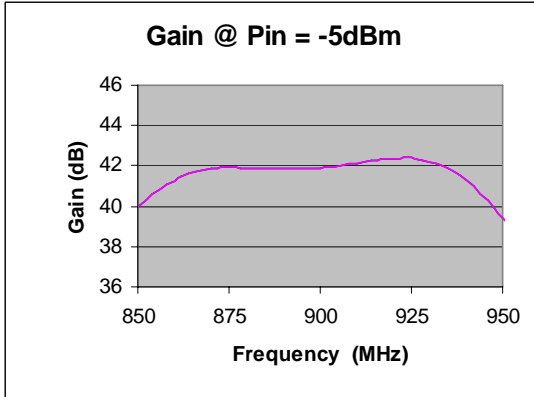



Typical Performance @ +25 °C

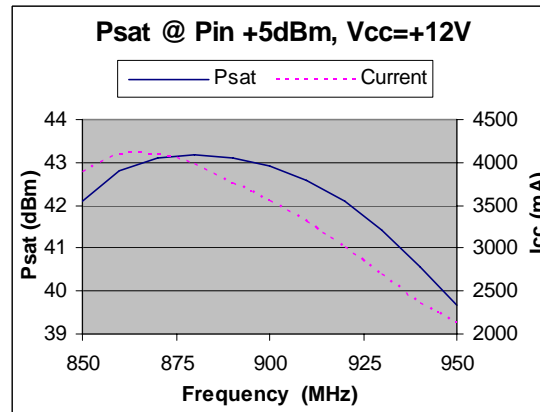
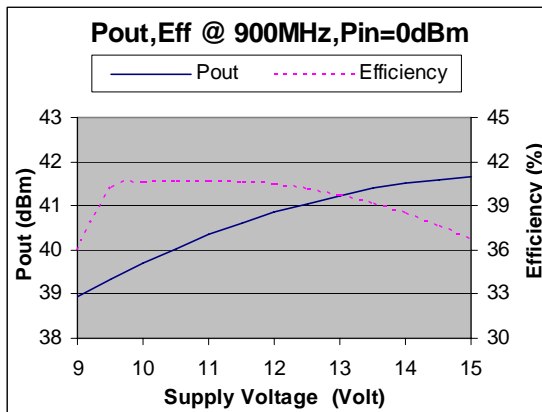
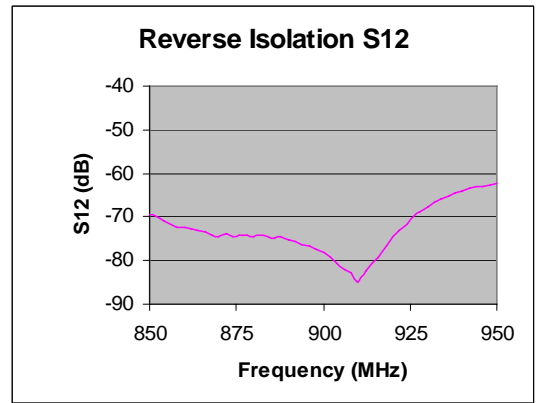
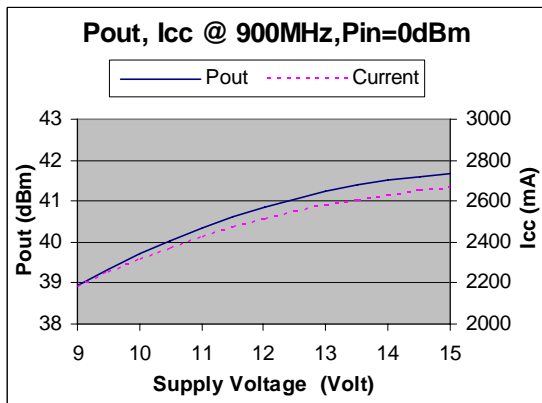
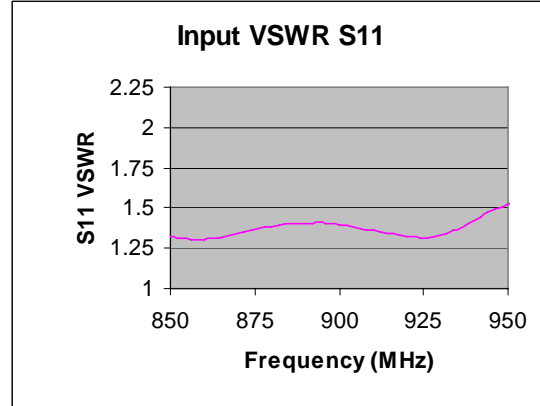
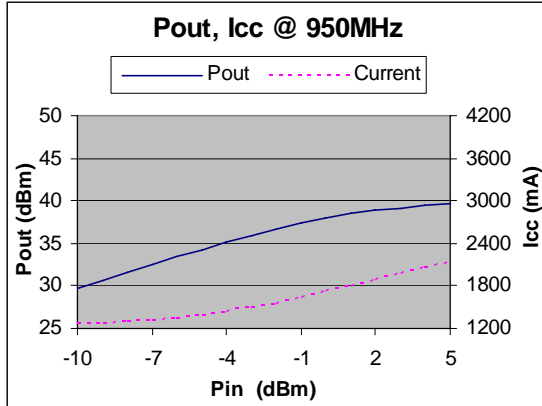



www.Shireeninc.com

HPA-900

HPA Series

850-950MHz 10W RF Power Amplifier

Absolute Maximum Ratings

Parameter	Absolute Maximum
RF Input Power	+15dBm
Supply Voltage	+16V
Operating Temperature	-30 °C to +65 °C
Storage Temperature	-55 °C to +100 °C

Outline

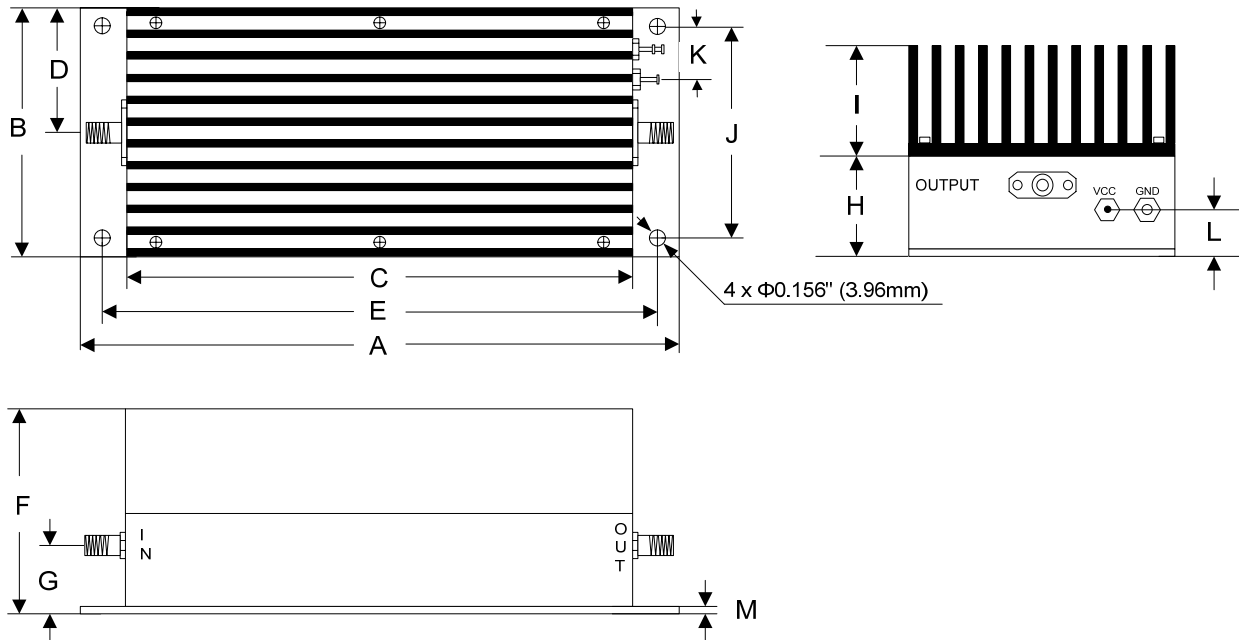

	A	B	C	D	E	F	G	H	I
Inch	7.000	3.250	6.000	1.625	6.500	2.000	0.650	1.000	1.000
mm	177.80	82.55	152.40	41.28	165.10	50.80	16.51	25.40	25.40
	J	K	L	M					
Inch	2.750	0.625	0.450	0.090					
mm	69.85	15.88	11.43	2.29					